

# ASPIRATEUR MITRALUX 20 x 40

GRANDE BASE

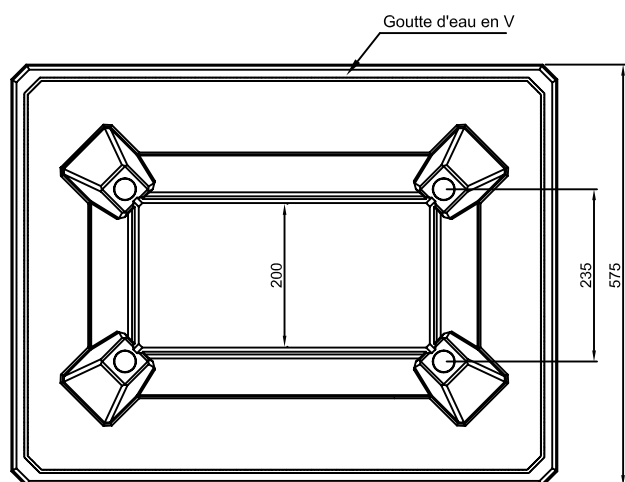

Code : 382083

Poids : 32 Kg

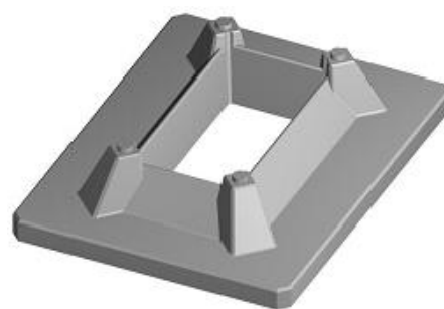
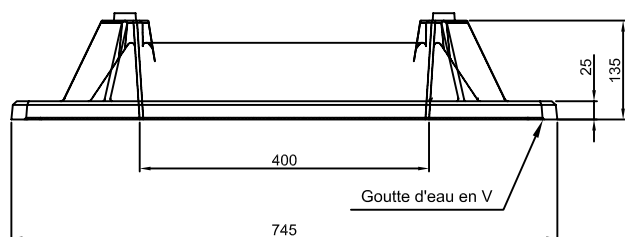

Elément de base

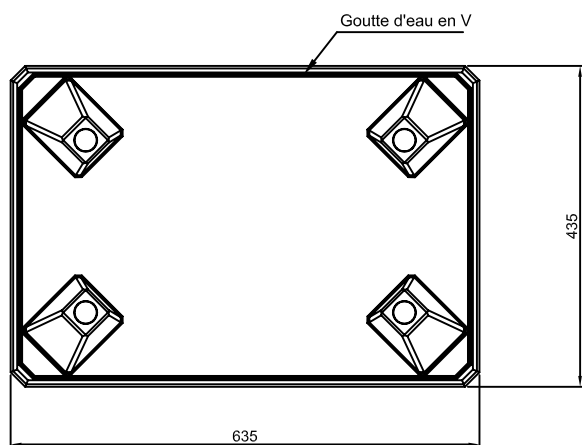

Code : 382082

Poids : 30 Kg

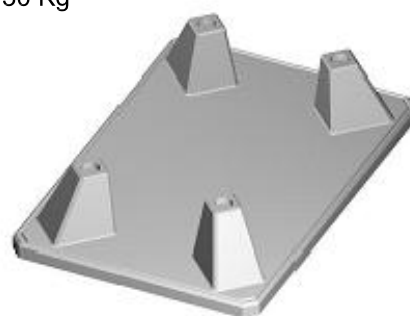
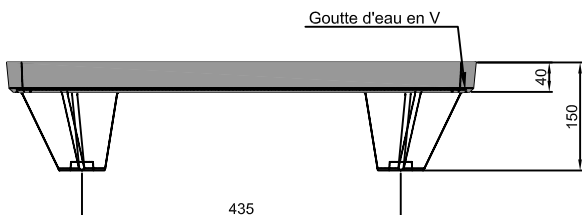

Elément supérieur

Code produit Aspirateur complet : 382085 Poids : 62 Kg

Conditionnement : Palette perdue de 6 unités Code : 382185 Poids : 372 Kg

**S.A. R.THEBAULT**

Siège social et usine : ZI de Saint-Eloi - Plouédern - 29800 LANDERNEAU

Tél. 02 98 21 63 63 - Fax : 02 98 21 34 11

Usines à : Mauron (56430) et Verneuil S/Avre (27130)

