

ASPIRATEUR MITRALUX 20 x 40

PETITE BASE

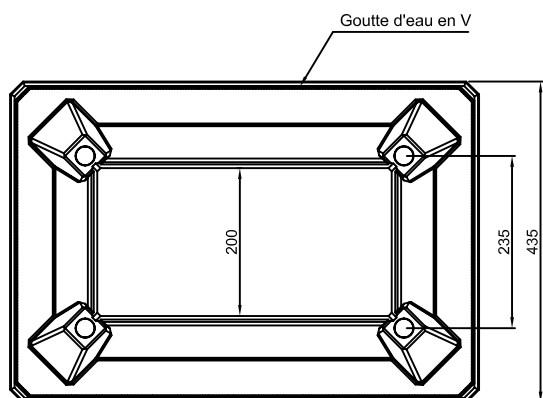

Code : 382081

Poids : 25 Kg

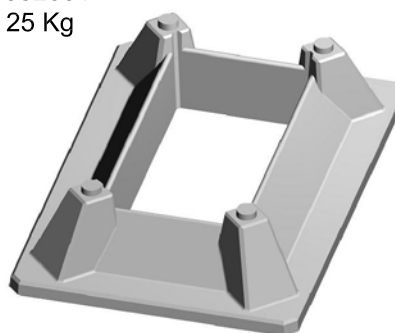
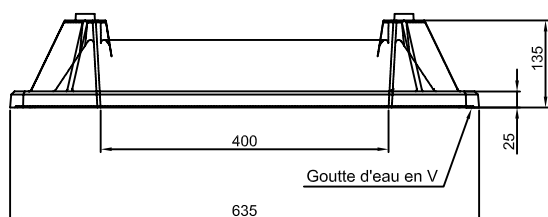

Elément de base

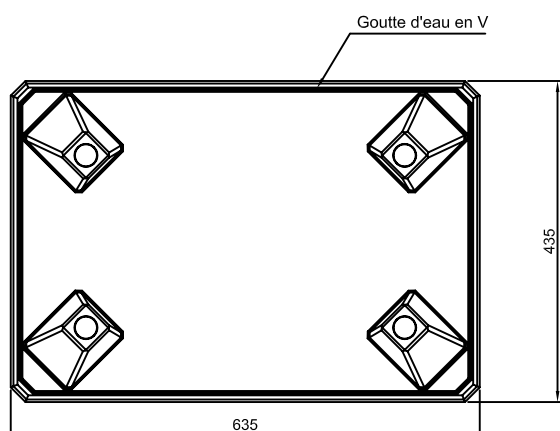

Code : 382082

Poids : 30 Kg

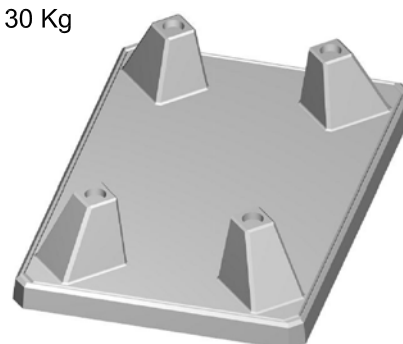
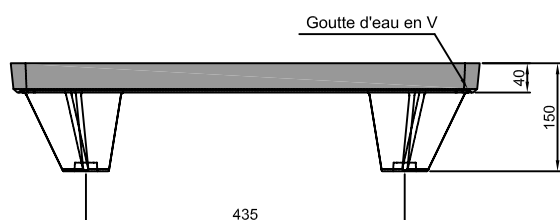

Elément supérieur

Code produit Aspirateur complet : 382080 Poids : 55 Kg

Conditionnement : Palette perdue de 15 unités Code : 382180 Poids : 825 Kg

S.A. R.THEBAULT

Siège social et usine : ZI de Saint-Eloi - Plouédern - 29800 LANDERNEAU

Tél. 02 98 21 63 63 - Fax : 02 98 21 34 11

Usines à : Mauron (56430) et Verneuil S/Avre (27130)

