

ASPIRATEUR MITRALUX 25 x 50

PETITE BASE

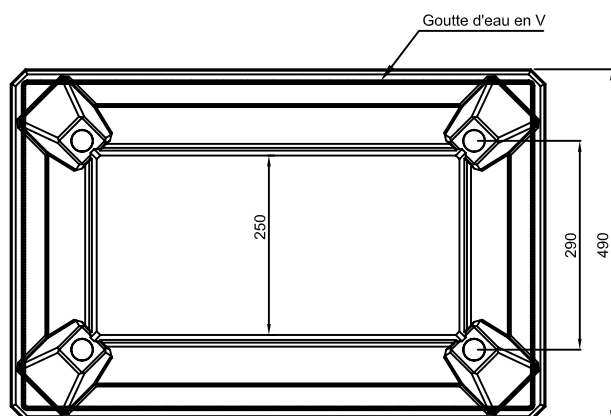

Code : 382051
Poids : 38 Kg

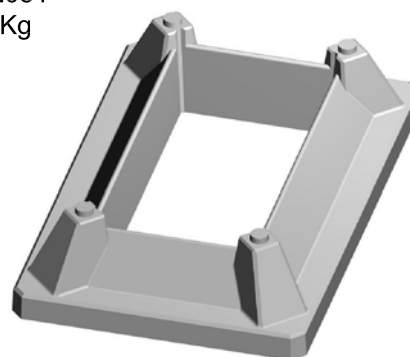

Elément de base

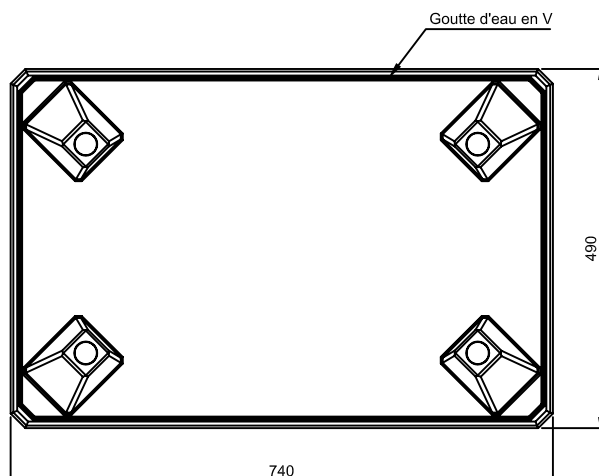
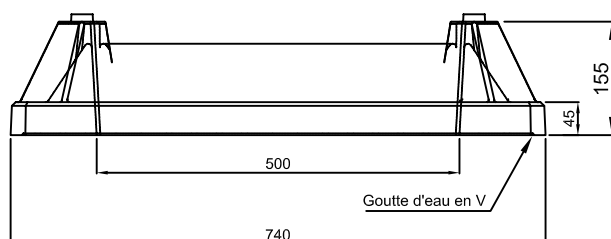

Code : 382052
Poids : 43 Kg

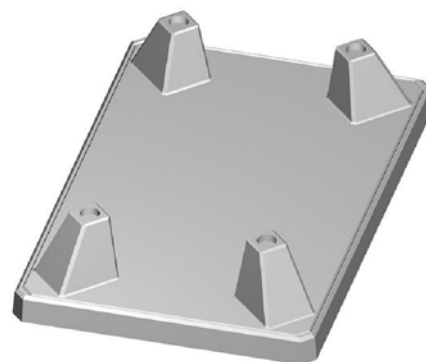

Elément supérieur

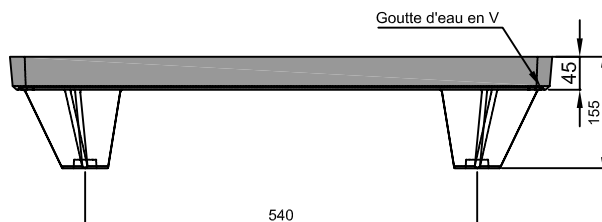

Code produit Aspirateur complet : 382050 Poids : 81 Kg
Conditionnement : Palette perdue de 6 unités Code : 382150 Poids : 486 Kg

S.A. R.THEBAULT

Siège social et usine : ZI de Saint-Eloi - Plouédern - 29800 LANDERNEAU

Tél. 02 98 21 63 63 - Fax : 02 98 21 34 11

Usines à : Mauron (56430) et Verneuil S/Avre (27130)

